



# MONROE METAL MFG. CO.

MONROE, NORTH CAROLINA

## RECTANGULAR DUCT AND FITTINGS STANDARDS

### GAUGE SCHEDULE

GALVANIZED	26 THRU 16 GA.
ALUMINUM	26 THRU 16 GA.
STAINLESS STEEL	26 THRU 16 GA.
PYS COATED	26 THRU 16 GA.
PAINT GRIP	26 THRU 16 GA.
ALUMINIZED	26 THRU 16 GA.

1985 SMACNA will be used OR AS SPECIFIED

### DUCT LINER

1/2" thick	= 2 lb. density
1" thick	= 1.5 lb. density
1" thick	= 3 lb. density

All lined ducts will receive a 100% coverage of adhesive on the internal duct surface. Welded pin fasteners are used on all ducts. CONTACT FACTORY FOR AVAILABILITY OF 3 LB. LINER.

### TRANSVERSE CONNECTORS

Flat "S" Lock - used up to 20"

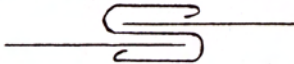

Standing "S" Lock - used over 20"



Pocket Lock - used when requested

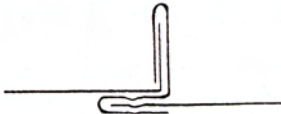

Flat drive slip - used up to 18"

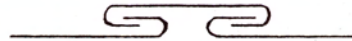

Capped Flange - used when requested



TRANSVERSE DUCT FLANGE (TDF) - used over 30" OR AS REQUESTED, MINIMUM 8".

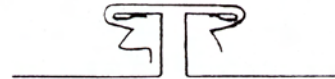

TRANSVERSE CONNECTORS MAY VARY ACCORDING TO WATER GAUGE OR UPON CUSTOMER REQUEST.

### LONGITUDINAL SEAMS

Pittsburgh Lock

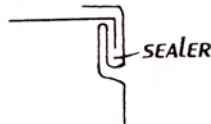

Button Punch Snap Lock

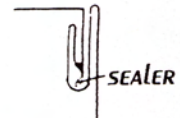

UNLESS OTHERWISE REQUESTED ALL DUCT WORK SHALL BE PITTSBURGH LOCK.

ALL RECTANGULAR DUCT AND FITTINGS ARE BEADED IF OVER 12", UNLESS OTHERWISE REQUESTED.

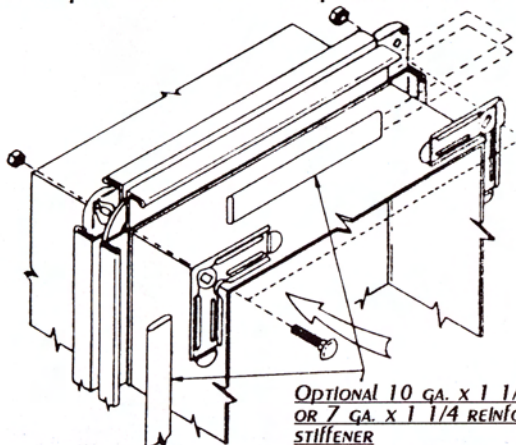

OPTIONAL 10 GA. X 1 1/4  
OR 7 GA. X 1 1/4 REINFORCING  
STIFFENER

NOTE: THESE ARE INSERTED ENDWISE BEFORE CORNERS ARE SNAPPED INTO PLACE.

### TDF CONNECTION WITH STIFFENER

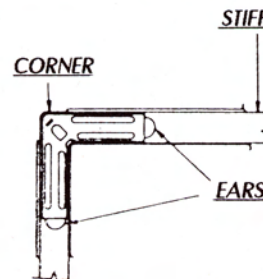

NOTE: CUT TO LENGTH, 6 1/4" SHORTER THAN DUCT SIZES.